

# WOODWRIGHTS



## LEANER

### Elka Leaner

A tactile leaner composed of solid timber slabs, defined by a negative detail running through the centre of the tabletop and legs. Designed to pair seamlessly with bar stools, offering a refined and elegant presence in shared or social spaces.

## DIMENSIONS

2000W x 805D x 1050H  
2200W x 805D x 1050H  
2400W x 1005D x 1050H  
2600W x 1005D x 1050H  
2800W x 1005D x 1050H  
3000W x 1005D x 1050H

## SPECIFICATIONS

- Solid ash or oak timber
- 5mm negative detail through end of leg frames
- Polished in a durable 2 pack lacquer
- Fully assembled

Made to order in New Zealand by Woodwrights

# WOODWRIGHTS

ELKA LEANER - 2000W x 805D x 1050H

CODE 11408

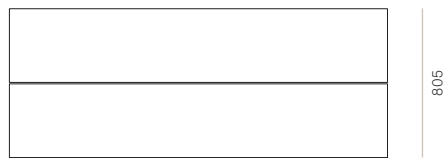
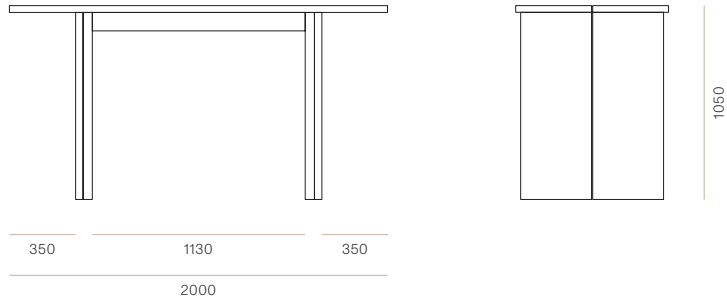

ELKA LEANER - 2200W x 805D x 1050H

CODE 11407

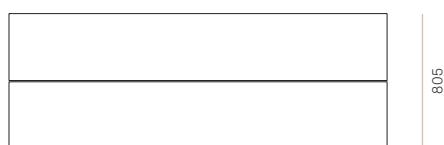
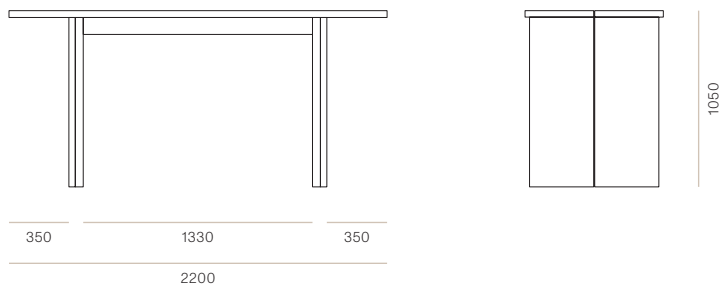

# WOODWRIGHTS

ELKA LEANER - 2400W x 1005D x 1050H

CODE 11406

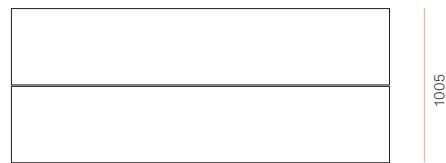
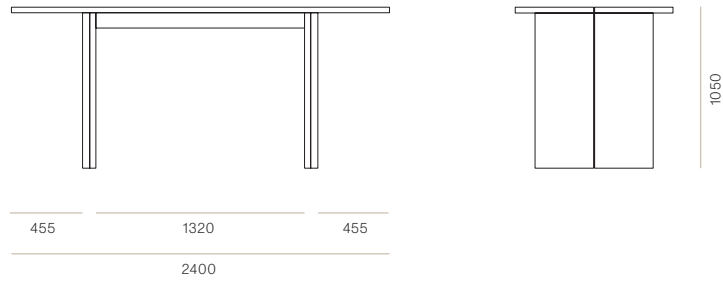

ELKA LEANER - 2600W x 1005D x 1050H

CODE 10580

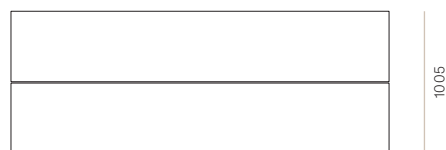
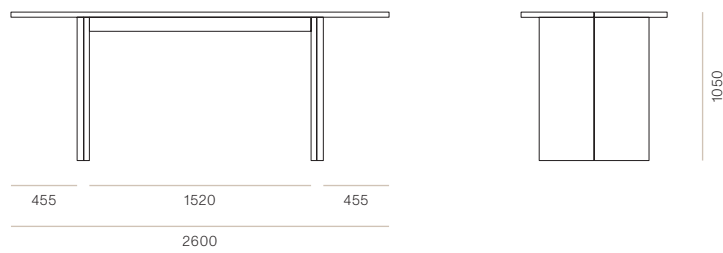

# WOODWRIGHTS

ELKA LEANER - 2800W x 1005D x 1050H

CODE 9477

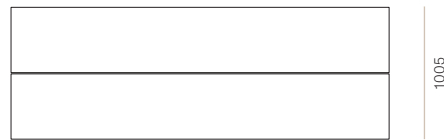
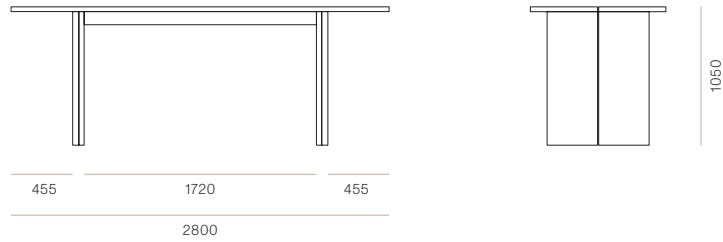

ELKA LEANER - 3000W x 1005D x 1050H

CODE 11405

